

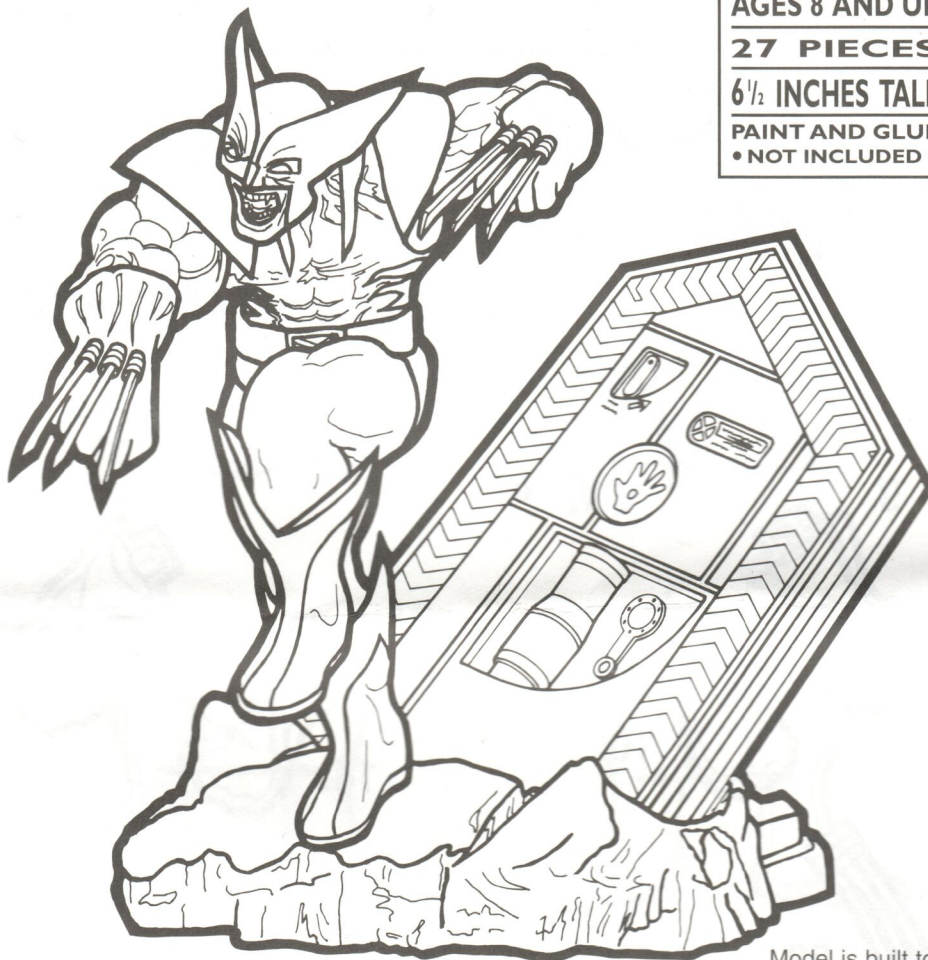

WOLVERINE™

INTERMEDIATE
AGES 8 AND UP
27 PIECES
6½ INCHES TALL
PAINT AND GLUE
• NOT INCLUDED •



Model is built to
 1/12 Scale

READ THIS BEFORE YOU BEGIN: • Study the assembly drawings. • Each plastic part is identified by a number. • Check the fit of each piece before snapping or cementing in place. • Do not use too much cement to join parts. • Use only cement for polystyrene plastic. • Model may be painted to match photos on the box. • Allow paint to dry thoroughly before handling parts. • Scrape paint from areas to be cemented. • For better paint and decal adhesion, wash the plastic parts in a mild detergent solution; rinse and let dry.

Artist: Nick Choles Sculptor: The Shiflett Brothers

Following a trail of mutant disappearances, Wolverine locates a hidden compound deep in the Rocky Mountains. Slicing through the compound's main door with his adamantium claws, Wolverine is shocked to find a Sentinel testing facility! Held prisoner, the captured mutants are being used to measure the Sentinel's combat abilities! Releasing the mutant prisoners from their cells, Wolverine destroys the compound's computers and equipment, making certain the facility is shut down for good!

STEP

1

Upper Body Assembly

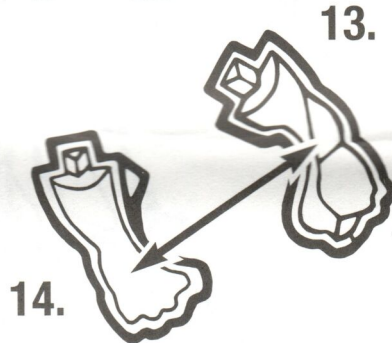
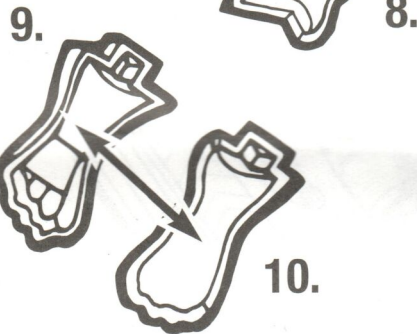
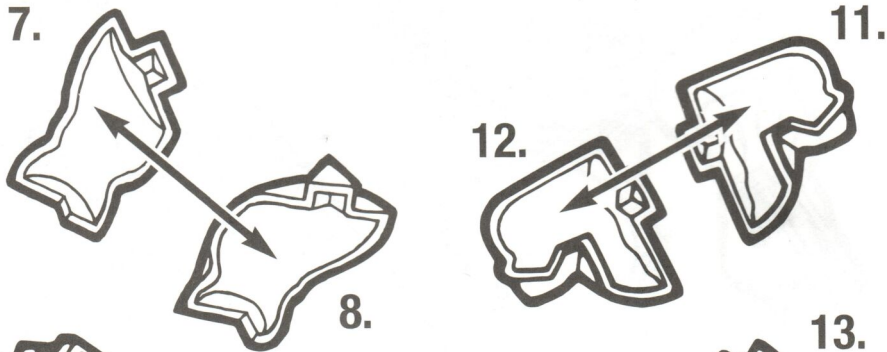
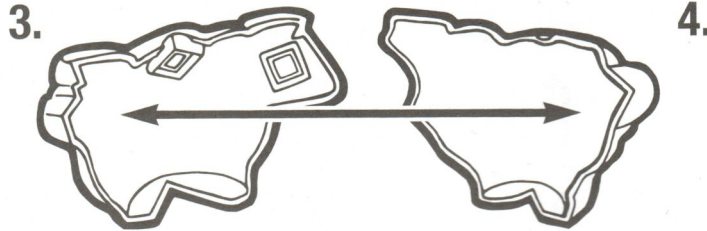
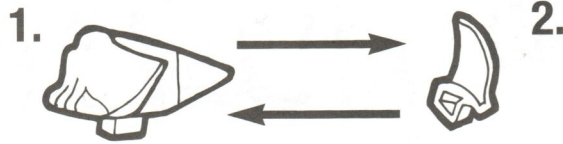

Completed Upper Body

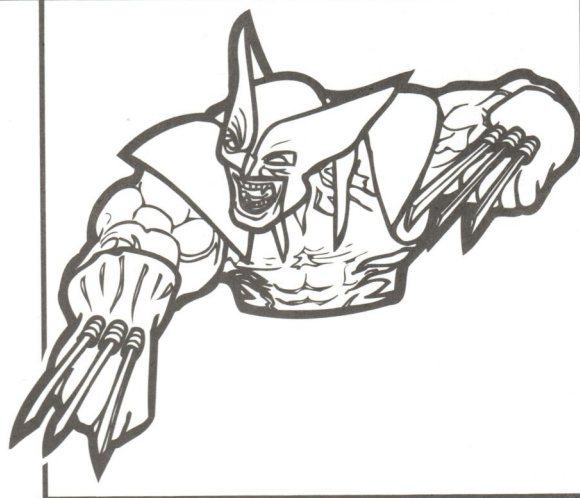

STEP

2

Lower Body Assembly

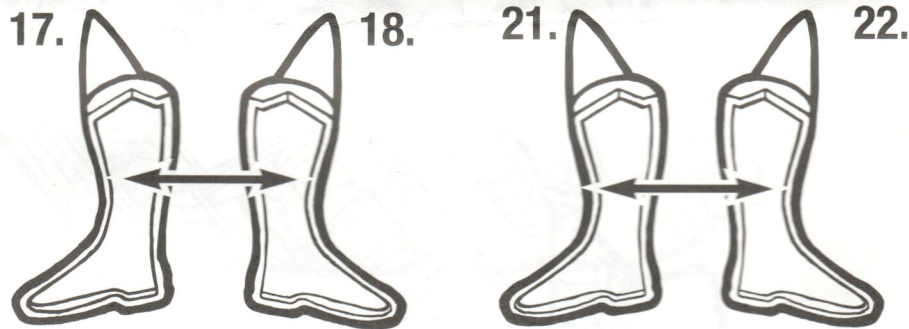
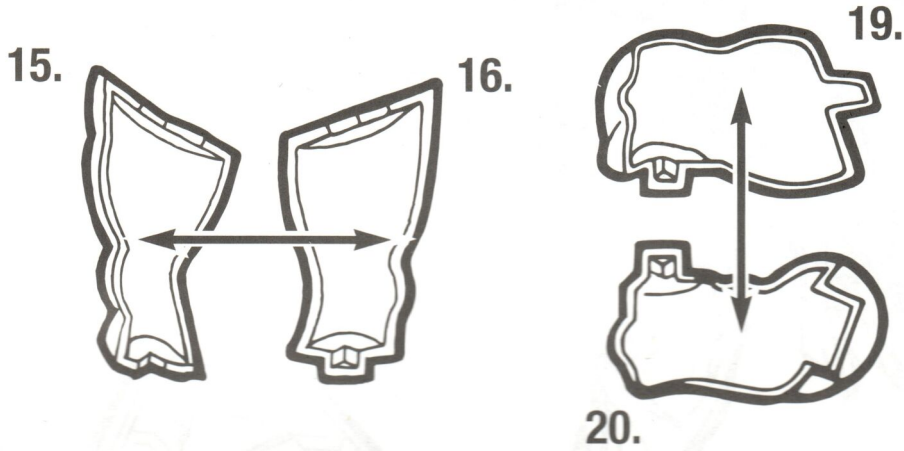
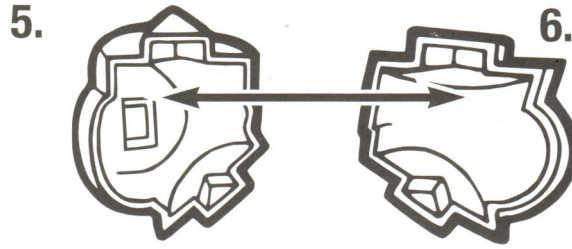

Completed Lower Body

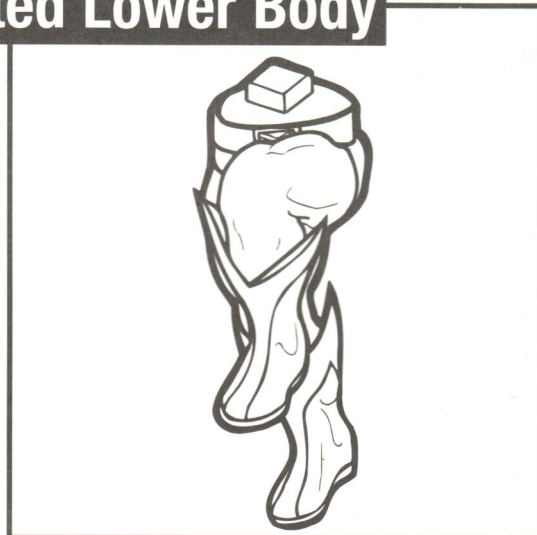

STEP
3

Body Assembly

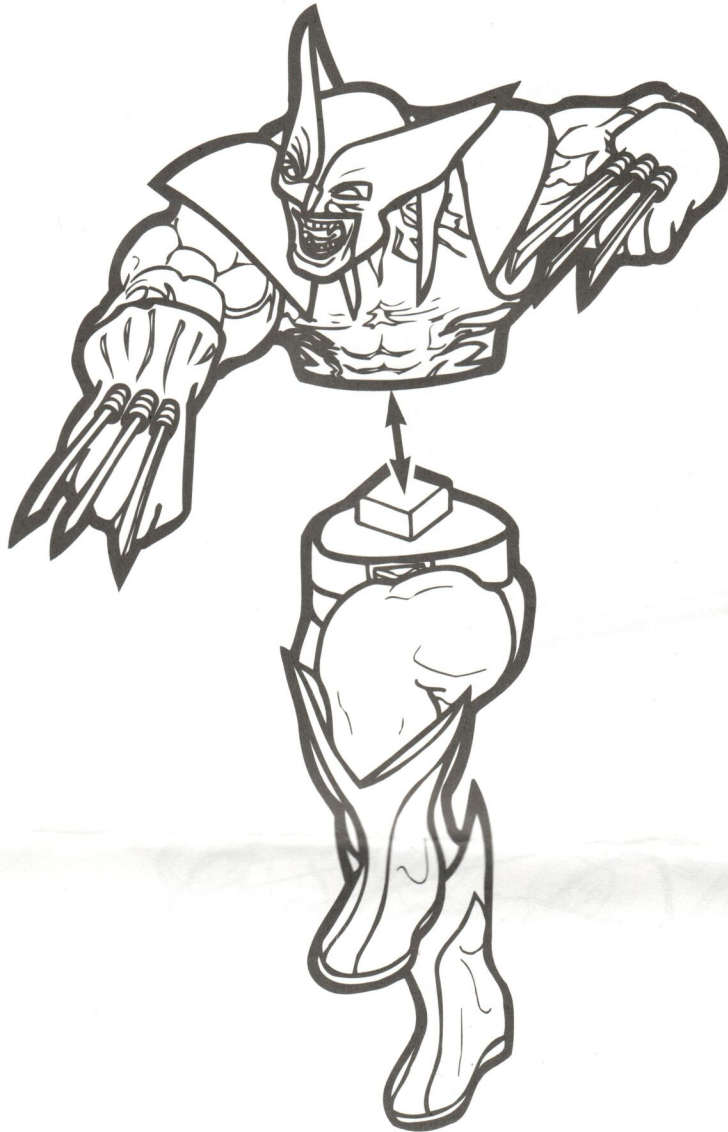

Completed Body

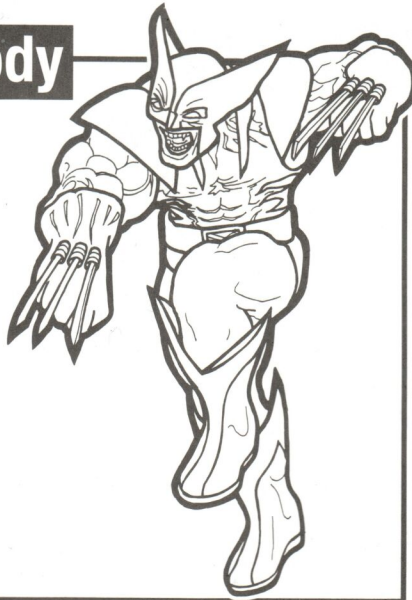

STEP

4

Base Assembly

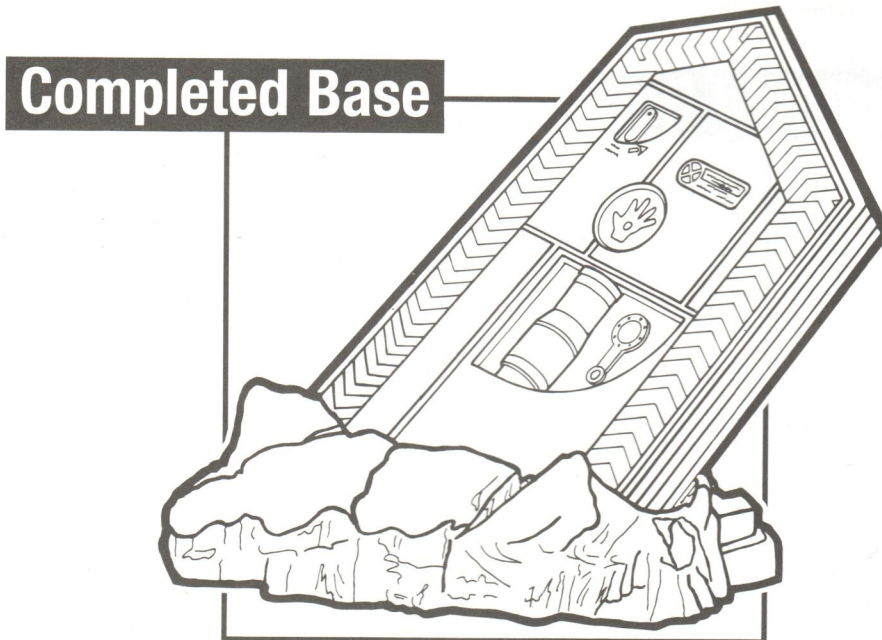
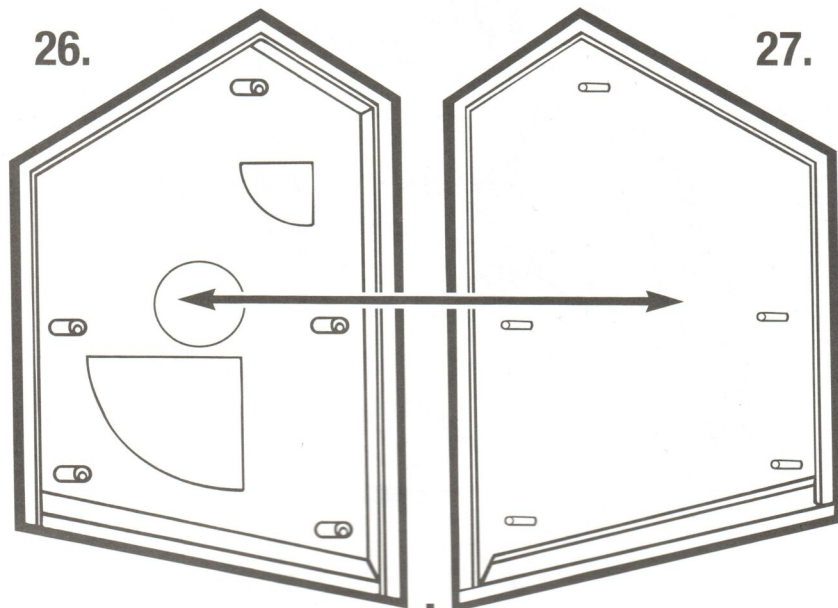

STEP
5

Final Assembly



TM and © 1996 Toy Biz, Inc.
All rights reserved. Printed in China.
© 1996 Marvel Characters, Inc.
All Rights Reserved.

**TOY BIZ™ TOLL FREE
CUSTOMER SERVICE NUMBER
1-800-634-7539**

